

OERLIKON

C 30

BEVEL GEAR TECHNOLOGY – CUTTING MACHINES



KLINGELBERG

LEADING IN BEVEL GEAR TECHNOLOGY

Flexible Solutions for Discerning Users

All around the world, manufacturers of gearwheels and gearboxes ensure their leading edge in gear machining with innovative solution concepts from Klingelberg.

The **Oerlikon Bevel Gear Technology** division does not just allow users to manufacture bevel gears economically and with high precision. All machines in the system have been designed to work together to enable pre-machining and finishing of even the most complex gears.

Klingelberg offers the most advanced technology and the most efficient machines for each and every step in the process chain. The production process chain for bevel gears includes **tool preparation, cutting, measuring, hardening, grinding** or **lapping** and **testing**, among others. The powerful **KIMoS (Klingelberg Integrated Manufacturing of Spiral Bevel Gears)** design software and the **Closed Loop concept** ensure transparency and documented quality throughout the entire process chain.

Oerlikon bevel gear machines were developed with real-world applications in mind and meet the varying demands of a whole range of application industries. The target markets include the automotive industry, the commercial vehicle industry, the agricultural industry, shipbuilding, and aviation, as well as industrial gearbox manufacturing and plant engineering.

Klingelberg, as a leading system supplier, also offers high-performance tools, and with this complete system, meets every requirement for flexible, efficient production – for the smallest and the largest lot sizes.

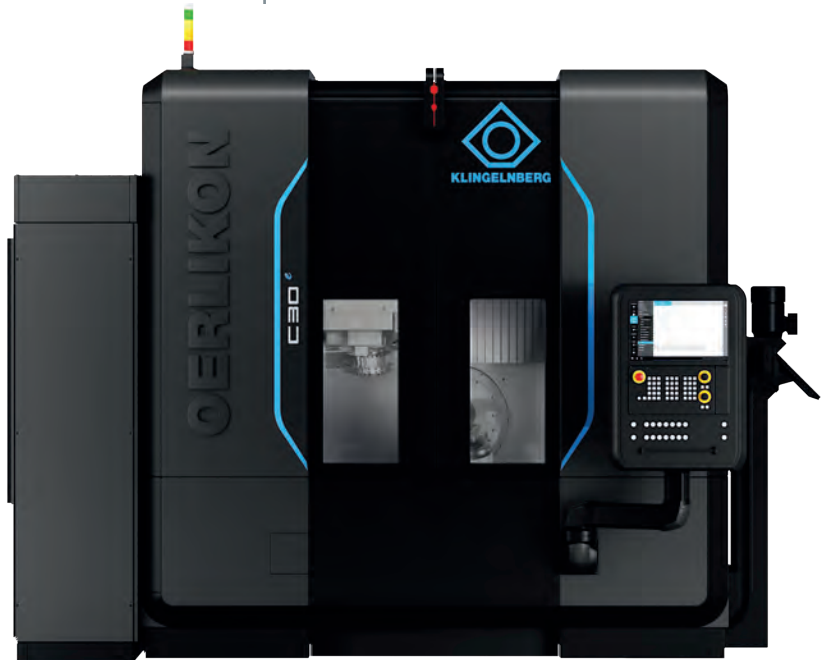

Oerlikon bevel gear cutting machine C 30 with numerous equipment details

For Every Process Step in Gear Technology,
Klingelberg Provides Exceptional Concepts

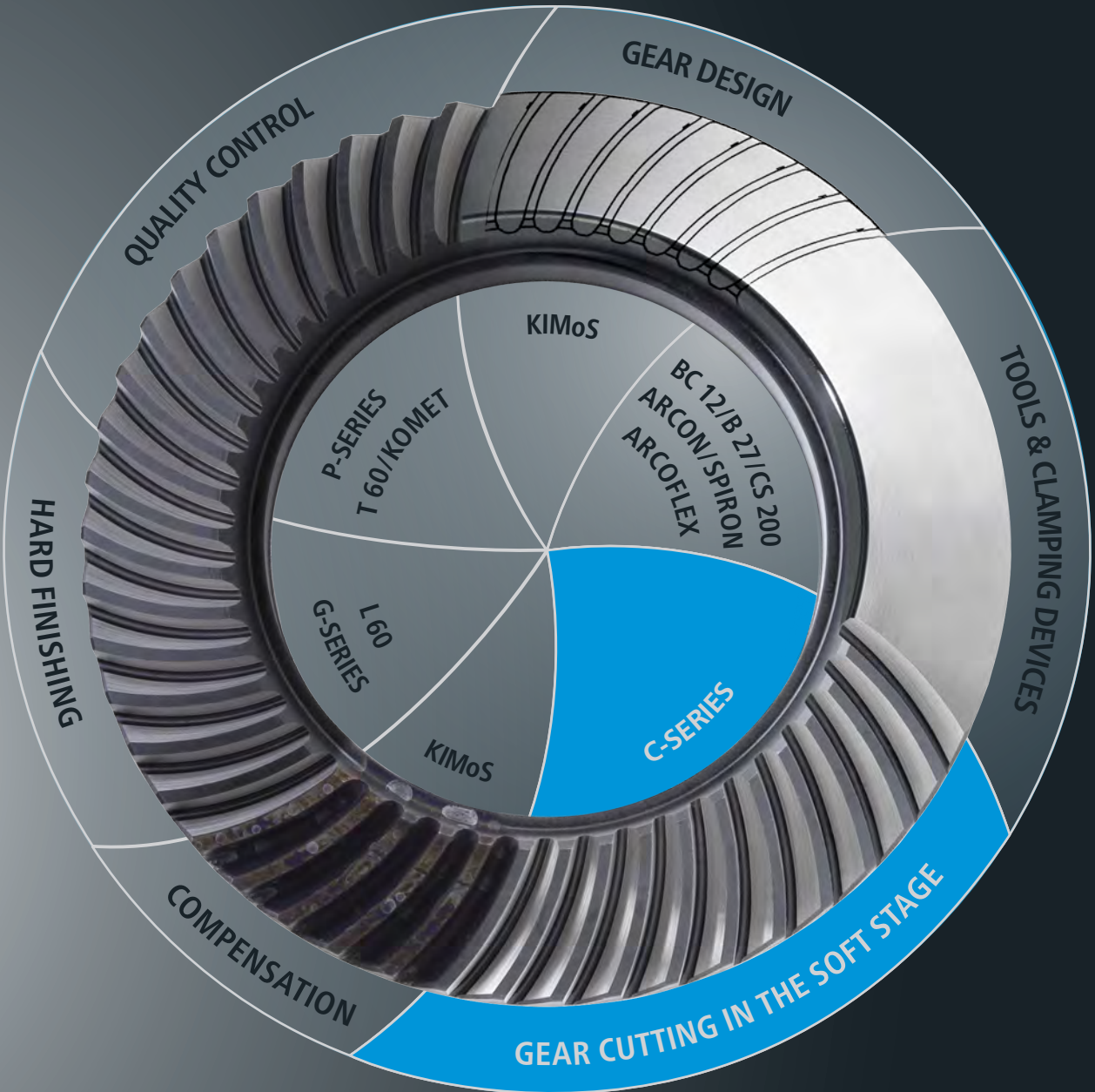

GEAR DEVELOPMENT BASED ON NOMINAL DATA

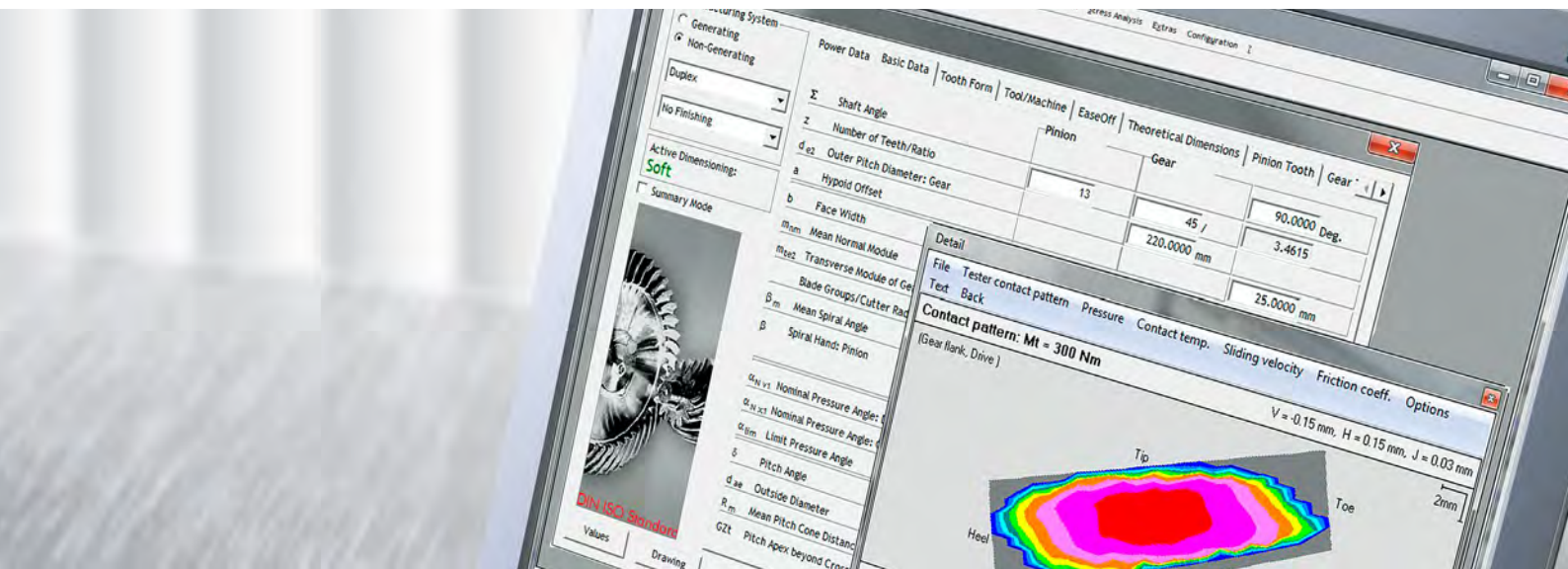

Digitizing Bevel Gear Production in the Age of Industry 4.0

The **KIMoS** (Klingelberg Integrated Manufacturing of Spiral Bevel Gears) software package supports every step in bevel gear design and optimization. Measurement results are converted into gear corrections with **KOMET**.

As part of this process, all necessary data for the gear cutting process, tool preparation and quality control of the finished bevel gears are prepared in parallel. At the same time, a convenient data handling system offers the possibility of using development and production databases to access machine tools in Production and Quality Assurance. The software package thus provides the optimal basis for ultra-modern bevel gear production according to the Closed Loop method: **The end result precisely matches what was previously designed and optimized on the computer.**

A modular program package, KIMoS provides the user with the whole range of functionality needed to create application-appropriate gear designs for every situation and supports all common gear-cutting methods, machines, and tool systems. Among the integral components of KIMoS are a gear-cutting optimization feature with easy-to-operate dialogs, analysis of the expected

gear operation behavior, and evaluation of the results with a load-capacity and strength calculation.

For gear design, KIMoS provides:

- Functional design with individual production possibilities taken into account
- Verification of gear design through various functions
- Cultivation of expertise within the company as a competitive advantage
- Fast, accurate analysis of testing and production results and gear damage

For gear production, KOMET provides:

- Reliable calculation of correction data in the precision measuring center
- Machine-specific correction data for bevel gear production
- Maximum process safety by interfacing with the Klingelberg database

Advanced Bevel Gear Production in a unique Closed Loop Process

KIMoS – for Optimal Design

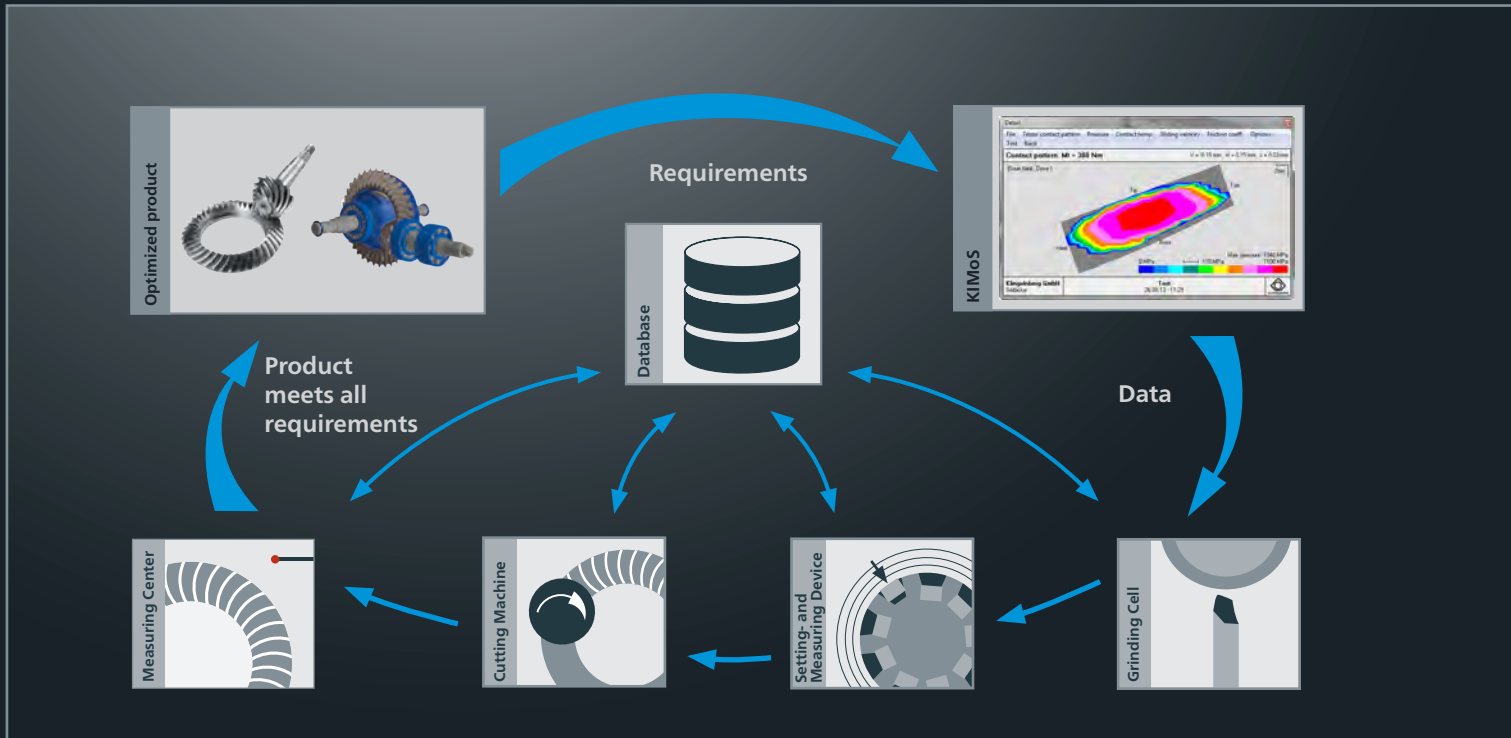

KOMET – from Design to Optimal Production Result

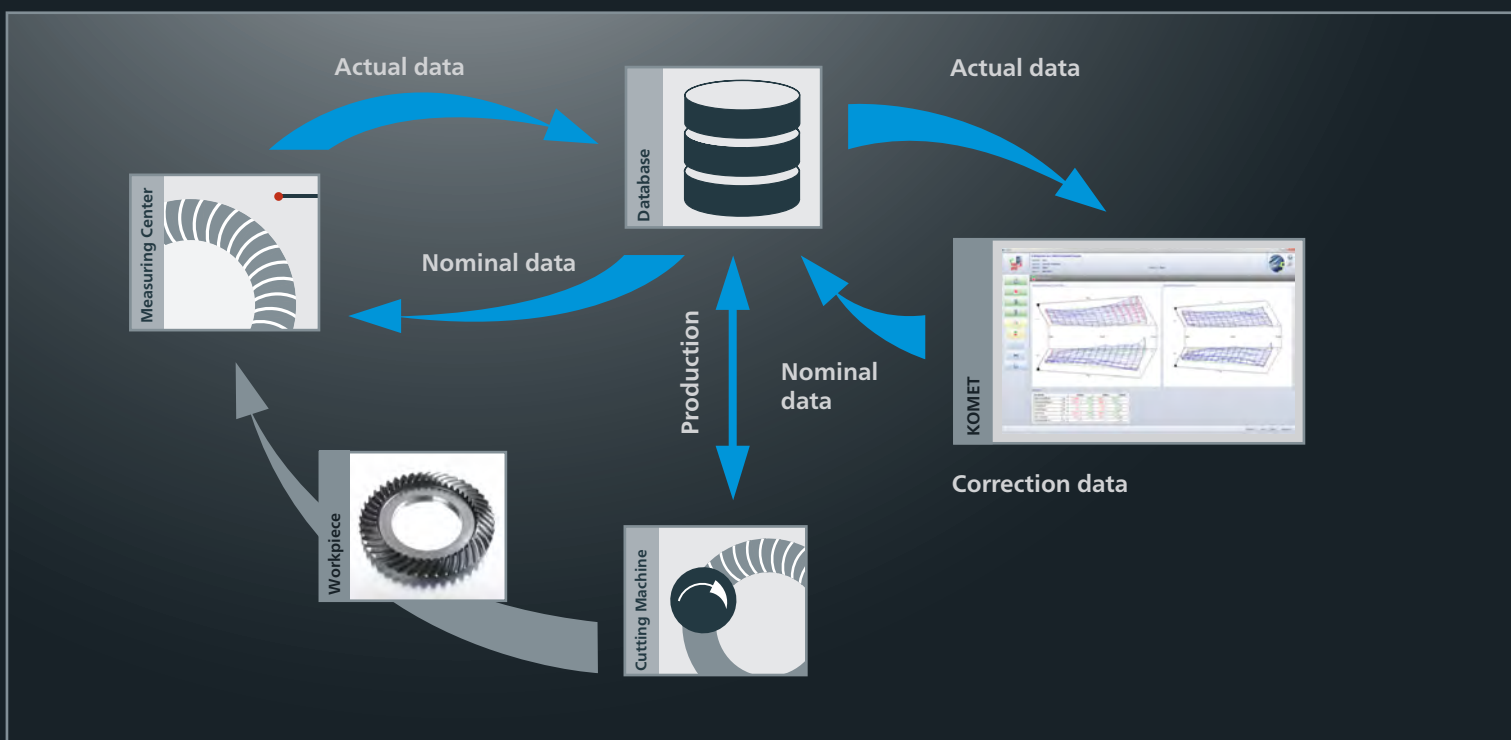

Leading-Edge Technology for Optimal Flexibility and Maximum Productivity

Thanks to ongoing advancement of the vertical concept, the Oerlikon bevel gear cutting machine C 30 sets new standards in dry processing.

All bevel gear machines in this series are equipped with a thermostable, vibration-damping machine bed. The cutting machine utilizes an optimized axis arrangement, resulting in reduced approach paths that ensure a significantly reduced load on the drive components and at the same time a stiffer design of the complete system. Moreover, an integrated deburring tool provides maximum productivity for deburring and the utmost process safety through the use of the PULSAR method. Use of the optional **Power Skiving method** makes it possible to achieve even greater machine flexibility and productivity.

A key highlight of this machine series is its innovative operating concept and ultra-modern control technology. The modern touchscreen display and the newly developed operating concept make the C 30 more intuitive to operate compared with standards commonly found on the market. (See page 11 for more on the operating concept.) For Klingelberg, it is also extremely important for all machine tools to be service- and maintenance-friendly. The advanced machine design makes maintenance work easier, significantly reduces the need to procure spare parts, and achieves maximum energy efficiency.

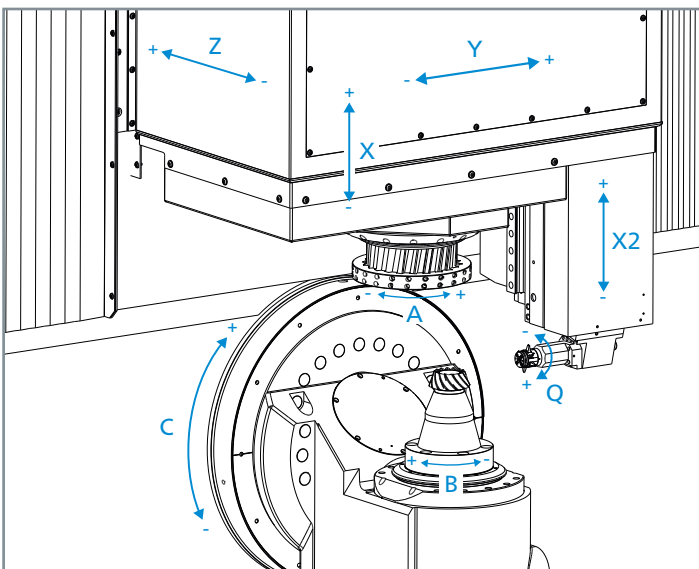

Axis arrangement of an Oerlikon bevel gear cutting machine C 30

- Continuous further development of the vertical concept with minimal traversing paths
- New materials with optimal attenuation properties while providing an extremely rigid construction and thermal stability
- Integrated deburring in the same clamping as for gear cutting
- New operating software with touchscreen display and clear screen layout
- Vertical spindle arrangement makes clamping device changes easy
- Optional **Power Skiving** of internal and external gearing by means of cylindrical monoblock tools
- Optimal energy efficiency thanks to recovery and on-demand control of units

Maximum Flexibility and Productivity – Changeover from Bevel Gear to Cylindrical Gear Production in No Time via **Power Skiving**

Circular arc (ARCON®)

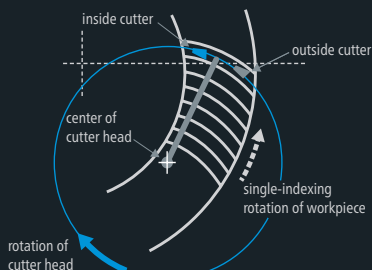

Epicycloid (SPIRON®)

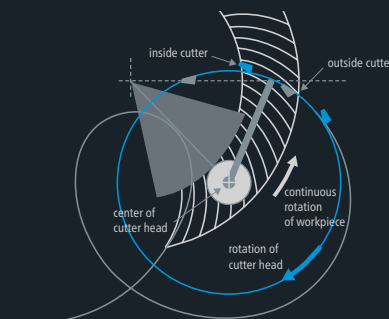

Straight gear (HYCON)

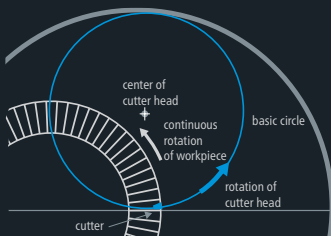

Power Skiving Internal gearing

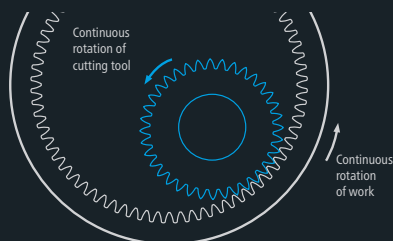
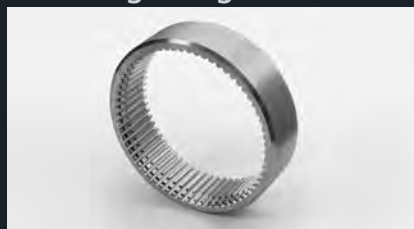

Power Skiving External gearing

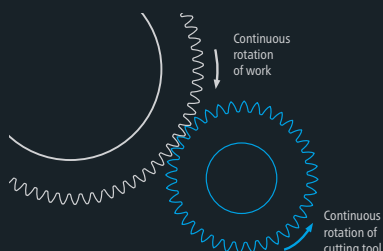

HIGHLIGHTS

High-tech can be so easy!

“Flexibility and productivity” – true to this motto, Klingelberg is driven to provide simple, unconventional solutions to high-tech challenges. A team of engineers and technical experts makes it possible — always with the goal of ensuring the highest technological standards in application-matched machine concepts that are also easy to use.

Case in point: the Oerlikon cutting machine C 30 is based on established development concepts that are continually being advanced. Klingelberg's success factors include:

- High productivity with the lowest possible per-piece costs and maximum process safety
- Unique Closed Loop concept for the entire bevel gearing process chain
- Improved tool system and just-in-time grinding service
- Comprehensive service offering with a broad service network
- Outstanding technical expertise and expert knowledge, which Klingelberg passes on to customers in professional seminars

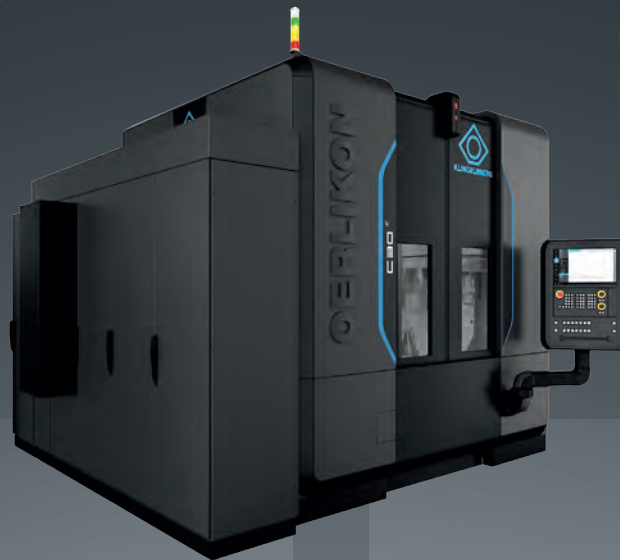

Unrivaled cycle speed – ring gear precutting

As demonstrated by this example of a 45-tooth ring gear in a passenger car, the dry cutting process can't be beat when it comes to speed:

- Dry gear cutting in 85 seconds with the Klingelberg ARCON® tool system
- Deburring of a flank on the heel in 8 seconds with the Klingelberg PULSAR deburring system
- Loading and unloading in 10 seconds with the machine-integrated loader
- Optionally, pitch can be measured and indexing error compensated on the first component

Thus the component can be completely cut, deburred and changed out in just **103 seconds**.



Maximum flexibility – Power Skiving of external gearing

The specifications of a cylindrical gear with 91 teeth from a passenger car application make clear how efficiently and reliably Power Skiving works:

- Power Skiving of the gearing with a PM-HSS monoblock tool in 104 seconds
- Process-integrated deburring of the outside contour with PULSAR in 40 seconds
- Loading and unloading with the machine-integrated loader in 10 seconds
- Measurement of pitch and tooth thickness on the machine is optional

Thus in **154 seconds** a workpiece is geared, deburred and changed out, making Power Skiving competitive with established gear cutting methods.



Optimal Chip Flow Thanks to Vertical Axis Concept

- Minimal heat input thanks to systematic avoidance of chip deposits in the working chamber
- Separate working chamber to protect drive components
- Foundation for trend-setting high-speed machining
- Optimized axis arrangement allows for optimal process monitoring
- Moving parts protected from damage caused by chips both inside and outside the working chamber
- Optimal energy efficiency thanks to recovery and on-demand control of units



Intelligent Production Process with Machine-integrated Start-up and Quality Assurance

- Short processing times and low tool costs make for economic production processes
- Measurements taken during the production process itself and automated calculation of corrections in the machine provide quality assurance for the production process
- High indexing quality is ensured over the entire service life of the tool via temperature compensation
- Ultimate quality in the face milling process thanks to automatic pitch compensation via software settings
- Optimized process sequences, machining times and tool life with Smart Process Control (optional)



Minimal Set-up Times

- Vertical axis concept makes it easy to access the workpiece clamping device
- Bayonet connector speeds up clamping device changes
- Integrated workpiece measurement system for automatic quality monitoring and faster production release following a component change
- Blade breakage monitoring allows for fast response to minimize downtime

HIGHLIGHTS

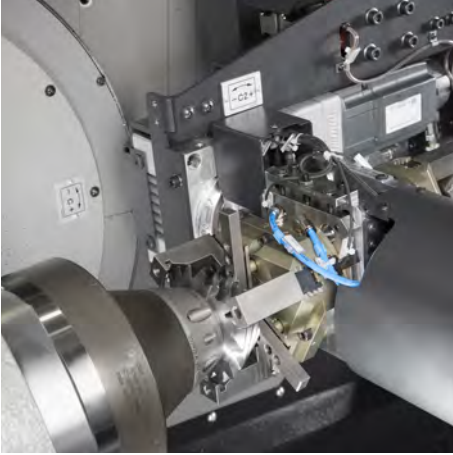

Minimal Auxiliary Times Thanks to High-Speed Workpiece Change

- Optimized workpiece changes, since loading system is fully integrated into the machine
- Standardized Profibus control interface for easy integration with external automation
- Integrated NC axes means intelligent coordination of machining process and workpiece changes
- Automatic workpiece changes, including for cylindrical gears cut by [Power-Skiving](#)



Process Design and Cylindrical Gear Production via [Power Skiving](#) in Closed Loop

- Virtual process design with Klingelnberg design software for optimal cutting conditions and absence of collisions during the process
- Automated correction of flank and profile deviations, as well as tooth thickness
- Flexible process data input for multiple-cut strategies enables verifiable component quality
- System-related high indexing accuracy from the continuous process



Flexible Deburring with PULSAR

- Visualization of the deburring paths ensures collision protection between the deburring tool, bevel gear cutting machine, and component
- Early-stage validation of production equipment and fast deburring setup, since all deburring development takes place outside the cutting machine
- Easy loading of centrally stored deburring processes minimizes tooling time during setup
- Deburring calculation for flank profiles of various manufacturing methods
- Deburring designs, including for external gearing produced by [Power Skiving](#)

Intuitive Operating Concept with Trendsetting Touch Technology for Bevel Gear and Cylindrical Gear Applications

- 1 Choice of multiple languages allows for worldwide use
- 2 Menu navigation is ultra-easy and requires minimal training thanks to innovative workflow support
- 3 Application errors are avoided by the intelligent warning function for preventing costly incidents and even accidents
- 4 Machine configuration is successfully completed in just a few steps

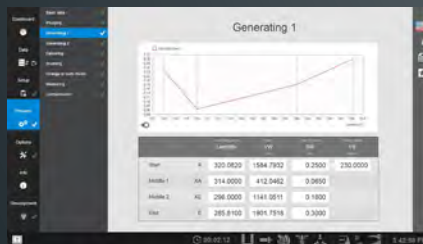
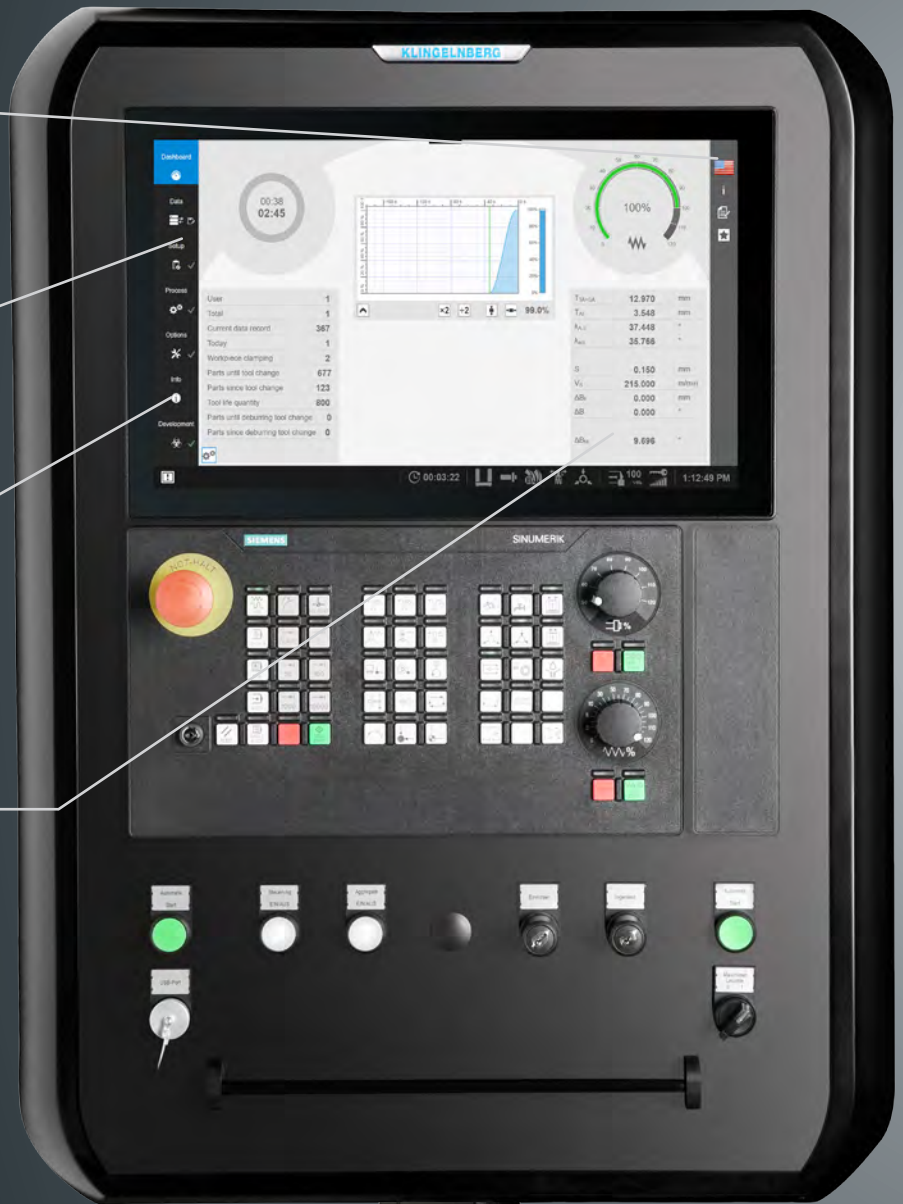

5 High production reliability ensured by visualization of the production workflow in real time (dashboard)

6 Fast and clear control of all process definitions via user interface

7 Simple, flexible process data entry for all gear cutting processes for bevel gears as well as for Power Skiving

Drive Components with Guaranteed Quality Provide Optimal Performance



In countless industries, Klingelberg solutions have become a fixture in the international market. To meet market requirements for high productivity in mass production and flexibility in small-batch production, Klingelberg offers a range of solution concepts for just about any requirement.

Used throughout the world, the "Simplified with Passion" system plays an important part in ensuring that machining tasks are made simple. Moreover, the Klingelberg system contributes to standardization and quality assurance on a global scale.

"Simplified with Passion" is also our motto for processing cylindrical gears with internal and external gearing by [Power Skiving](#). This significantly improves the Oerlikon C 30 bevel gear cutting

machine's flexibility of application. This process can be used in both small-scale and mass production. Through a software-assisted process simulation, the optimal tool dimensions and appropriate process parameters for each individual application are determined and made available for production and quality assurance that meet the requirements of Industry 4.0.



Automotive



In cars, spiral bevel gears are used in all-wheel-drive systems and rear-wheel-drive systems to transmit torque "from the transmission to the road." Due to increasing performance requirements, these drives must transmit outputs of over 300 kW in some cases. The bevel gears must be efficient, smooth-running, and low-maintenance. In all-electric passenger cars, cylindrical gear transmissions will be used in the future to transmit power. Owing to the high rotation speeds, geometric accuracy is expected to meet rigorous demands.

Lightweight Commercial Vehicles



Rear-axle differentials are frequently used for lightweight commercial vehicles. The bevel gear sets they use must transmit power in the range of 550 kW – at extremely high torques. This places high demands on durability and strength. The bevel gears must be efficient, rugged, and low-maintenance. Use of the integrated Klingelberg system makes it possible to mass-produce bevel gears with the quality required.

Industrial Gear Units



The industrial gear unit sector comprises many different applications, all of which place great demands on the reliability of the drive components. The bevel gears for these sectors are often produced by companies specializing in small batch sizes and a variety of products. A rigid machine design and flexible, cost-effective tool systems are the keys to success for ranking among the market leaders in these sectors.

Aviation



Bevel gears used in airplanes must embody the highest quality in terms of pitch and concentricity (DIN 1–3) and must also execute rotational movements with absolute reliability. Just as important are other geometrical features such as surface finish, root geometry, rotational errors, high strength and low weight. Frequently used in this industry are specialty materials, which place extreme demands on tools and processes.

Maritime Propulsion Technology



The bevel gears used in maritime propulsion technology must demonstrate great reliability and durability even under the most extreme external conditions. The wide range of component diameters (up to 2 m) requires extensive bevel gear know-how to master the design and production process. Klingelberg's many years of experience and its certification by all major classification societies are the customer's guarantee of the utmost product quality.

Agriculture



In agricultural applications such as tractors, spiral bevel gears are built into the rear axles, as well as the front axles in certain cases. Harvesters and hay machines use straight bevel gears to enable the corresponding functions. Whereas the bevel gear set in a tractor rear axle drive must transmit up to 400 kW, the loads on straight bevel gears are comparably low. The most important market requirement for straight bevel gears is a modern production solution that is cost-efficient.

TECHNICAL DATA

	Face hobbing (continuous indexing)	Face milling (single indexing)
Workpiece data		
Workpiece diameter (max.)	Ø 280 mm	
Normal module range (min. – max.)	1.5 – 6.5 mm	
Face width (max.)	58 mm	
Smallest / largest spiral angle	0°/60°	
Smallest / largest number of teeth	6/180	
Smallest / greatest transmission ratio	1:1/1:10	
Tool data		
Cutter head radius / Cutter head diameter	39–105 mm	3.25" – 7.5"
Number of blade groups (continuous)	5 -19	-
Cutter head spindle (A-axis)		
Short cone taper 1:24	Ø 58.227 mm	
Spindle rotation speed (max.)	1,500 rpm	
Workpiece spindle (B axis)		
Seating diameter: Oerlikon outer cone 1:4	Ø 140.11 mm	
Inner cone 1:19.764	Ø 99.258 mm	
Workpiece spindle passage	Ø 93 mm	
Workpiece spindle speed (max.)	1,500 rpm	
Total connected load	40 kVA	
General machine data		
Machine dimensions L x W x H*	approx. 4,500 x 3,410 x 2,900 mm	
Net weight	approx. 20,000 kg	

The above-mentioned maximum values were determined for industry-typical transmissions. Further testing may be required to determine whether maximum values can be combined.

*The dimensions of the standard version are for orientation only. Swivel ranges for doors, operating panels etc. are not taken into account here. The final space requirement depends on the individual configuration of the machine.

Installation Dimensions

C 30: Front View and Top View

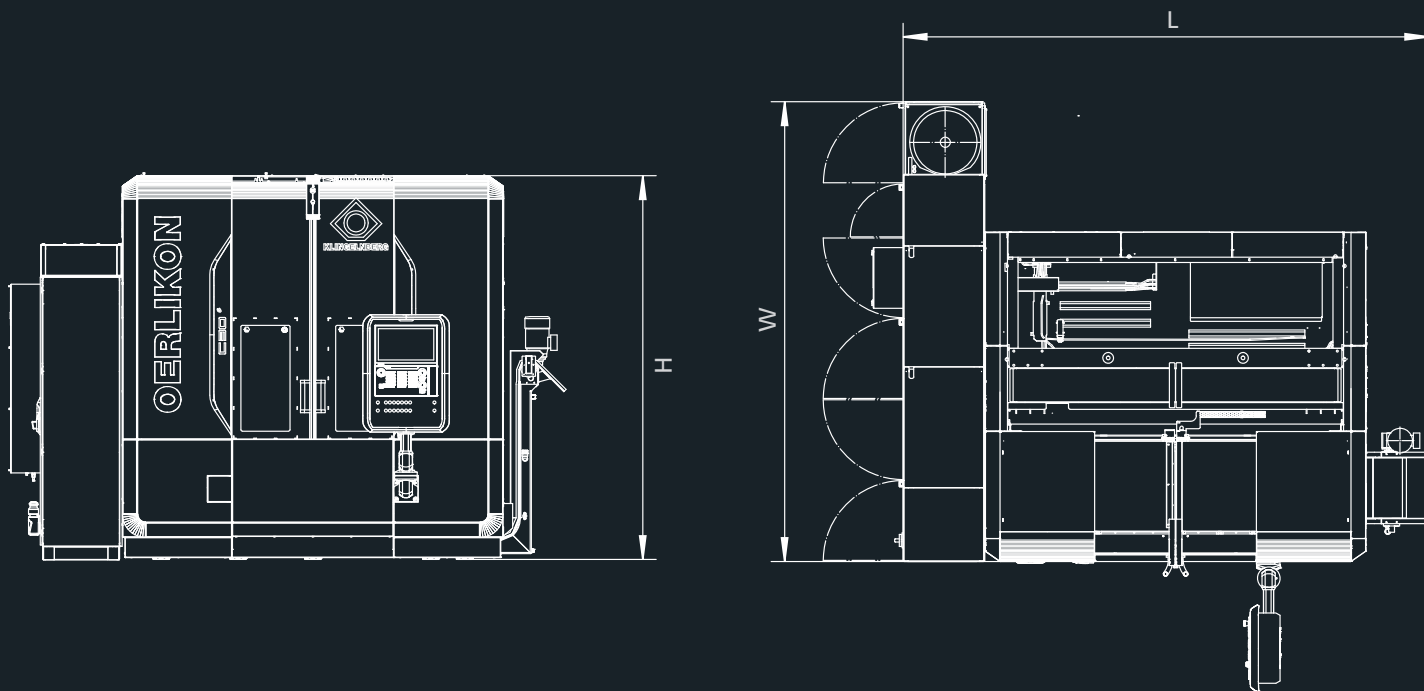

All dimensions in mm.

Power Skiving			
Module	0.8 – 3.5 mm	Rotations per minute	
Internal gearings		A axis	B axis
Reference circle diameter (min. – max.)	Ø 60 – 300 mm	1,500 rpm (2,100 rpm special design)	1,500 rpm
Face width (max.)	70 mm		
External gearings			
Reference circle diameter (min. – max.)	Ø 50 – 210 mm	1,500 rpm	1,500 rpm
Face width (max.)	70 mm		

These data are guideline values. Klingelberg will verify the applicability of the C 30 in each specific case.

KLINGELNBERG Service

The KLINGELNBERG Group is a world leader in the development and manufacture of machines for bevel gear and cylindrical gear production, and precision measuring centers for gearing and axially symmetrical components, as well as the production of customized high-precision drive components. In addition to the headquarters in Zurich, Switzerland, further development and production facilities are located in Hückeswagen and Ettlingen, Germany.

The company also maintains a presence with Sales and Service offices and numerous marketing agents. On this basis, Klingelberg offers users a comprehensive range of services for all aspects of toothed gear design, manufacturing, and quality inspection. The spectrum includes technical consulting, on-site machine acceptance, operator and software training as well as maintenance contracts.

KLINGELNBERG Solutions

Klingelberg solutions are used in the automotive, commercial vehicle, and aviation industries, as well as in shipbuilding, the wind power industry, and the general transmission manufacturing industry. With numerous R&D engineers around the globe and over 200 registered patents, the company consistently demonstrates its capacity for innovation.

EN 12/2020 - Subject to technical modifications without notice.

FOLLOW US AND STAY UP TO DATE:



KLINGELNBERG AG

Binzmühlestrasse 171
8050 Zürich, Switzerland
Fon: +41 44 278 7979
Fax: +41 44 273 1594

KLINGELNBERG GmbH

Peterstraße 45
42499 Hückeswagen, Germany
Fon: +49 2192 81-0
Fax: +49 2192 81-200

KLINGELNBERG GmbH

Industriestraße 5-9
76275 Ettlingen, Germany
Fon: +49 7243 599-0
Fax: +49 7243 599-165

You can also find your local contact for sales advice at www.klingelberg.com/kontakt